

Peak Emission Wavelength: 370nm

The 370nm UV emitter is specifically designed for applications requiring high power output and accuracy in a dome lensed metal package. Custom package solutions and sorting are available.

FEATURES

- > High Output Power
- > Metal Can Package
- > High Reliability
- > Narrow Beam Angle

APPLICATIONS

- > Currency Validation
- > UV Curing / Bar-code Reader
- > Counterfeit Detection
- > Medical Phototherapy

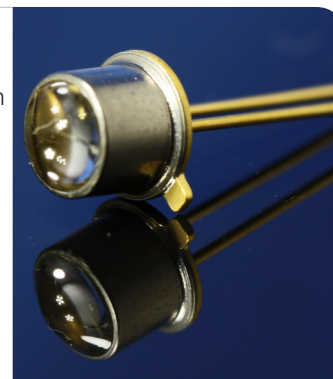

Absolute Maximum Ratings (Ta=25°C)



ITEMS	SYMBOL	RATINGS	UNIT
Forward Current (DC)	IF	15	mA
Forward Current (Pulse)*1	IFP	30	mA
Reverse Voltage	VR	5	V
Power Dissipation	PD	60	mW
Operating Temperature Range	Topr	-20 ~ +80	°C
Storage Temperature Range	Tstg	-30 ~ +100	°C
Junction Temperature Range	Tj	100	°C
Lead Soldering Temperature*2	Tls	260	°C

*1: Tw=10µsec, T=10msec. *2: Time 5 Sec max, Position: up to 3mm from the body.

Electrical & Optical Characteristics (Ta = 25°C)

ITEMS	SYMBOL	CONDITIONS	MIN	TYP	MAX	UNIT
Power Output	PO	IF=10mA	--	1.0	--	mW
Forward Voltage	VF	IF=10mA	--	3.8	--	V
Reverse Current	IR	VR=5V	--	--	80	mA
Peak Emission Wavelength	λ_p	IF=10mA	--	370	--	nm
Spectral Line Half Width	$\Delta\lambda$	IF=10mA	--	15	--	nm
Half Intensity Beam Angle	Θ	IF=10mA	--	±5	--	deg

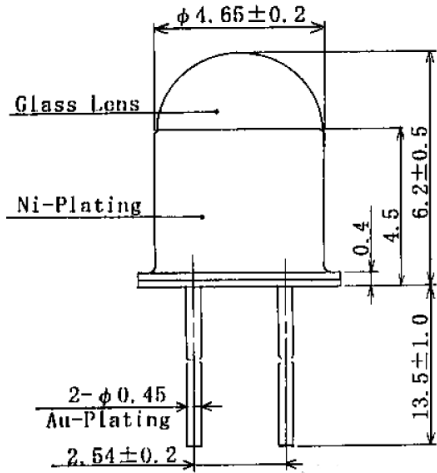

SPECTRAL OUTPUT

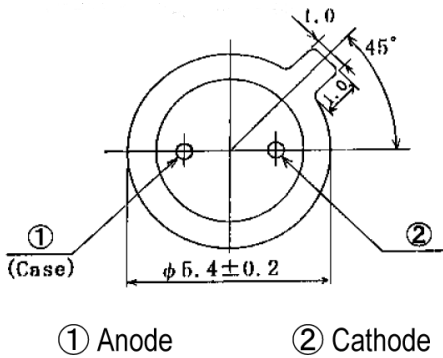
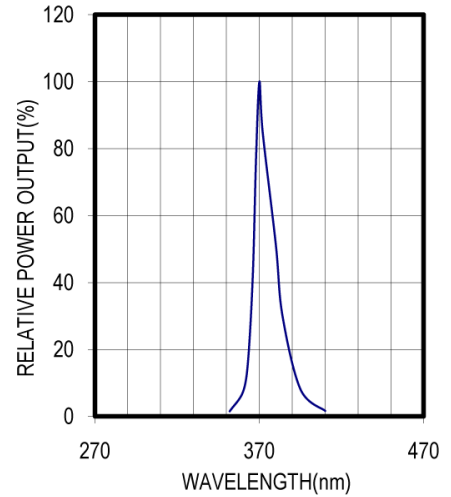

FORWARD I-V CHARACTERISTICS

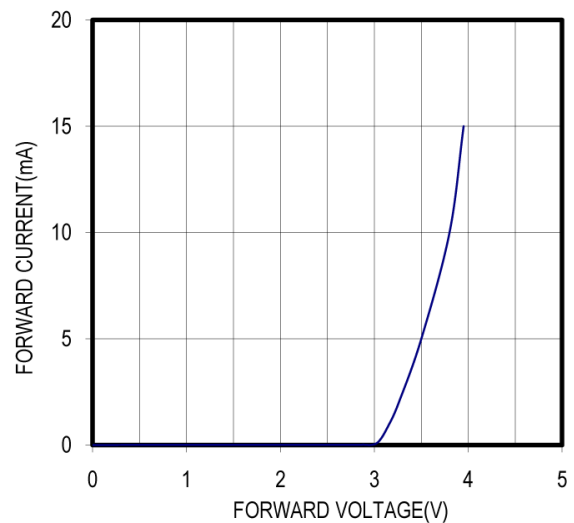

Unit: mm, Tolerance: ± 0.15

RELATIVE POWER vs FORWARD CURRENT

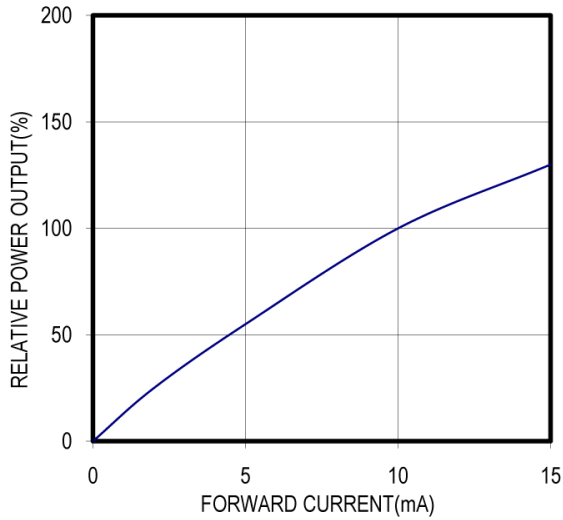

RADIATION PATTERN

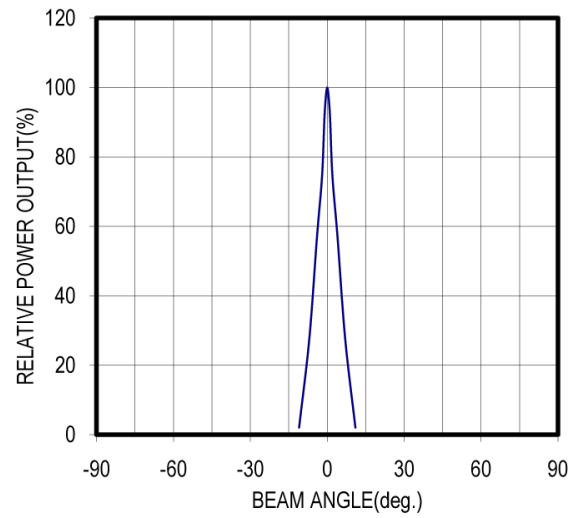

THERMAL DERATING CURVE

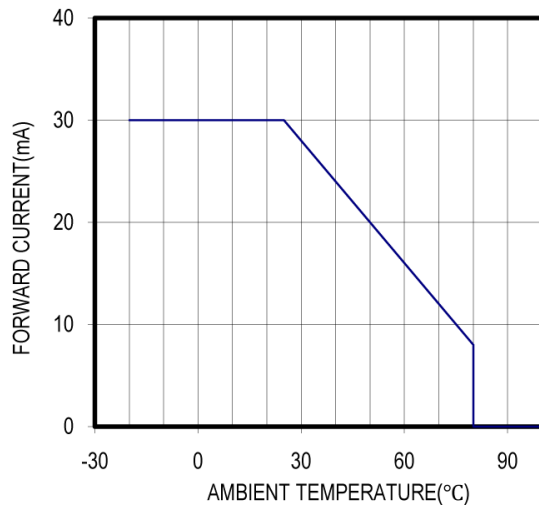

The information contained herein is subject to change without notice.

2012-04-12