

# Cree® PLCC6 3 in 1 SMD LED CLY6C-FKC

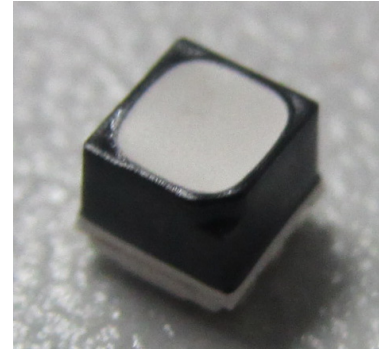

## PRODUCT DESCRIPTION

This SMD LED features an IPx8 water resistant rating in a PLCC6 package. These high performance tricolor SMT LEDs are designed to work in a wide range of applications. A wide viewing angle and high brightness make these LEDs suitable for outdoor and full color video signage applications.

The encapsulation resin contains UV inhibitors to minimize the effects of long-term exposure to direct sunlight, resulting in stable light output over the life of the LED. This PLCC6 package has an increased package height to ease in the manufacturing process.

## FEATURES

- Size (mm): 2.8x2.8x2.5
- Dominant Wavelength:  
Red (619 - 624nm)  
Green (520 - 540nm)  
Blue (460 - 480nm)
- Luminous Intensity (mcd)  
Red (355 - 805)  
Green (710 - 1400)  
Blue (140 - 355)
- Water-Resistant (IPx8)\*
- Moisture Sensitivity Level: 5a
- Lead-Free
- RoHS Compliant

## APPLICATIONS

- Outdoor Full-Color Video Screen
- Decorative lighting
- Amusement

\*: This part is tested under the condition of assembling it on a PCB with isolating the electrical path by silicone. The leads area of the LED is not IPx8 rated and it's required to insulate for moisture by customer in outdoor application.

### ABSOLUTE MAXIMUM RATINGS ( $T_A = 25^\circ\text{C}$ )

| Items  | Symbol     | Absolute Maximum Rating |     |     | Unit                      |
|--|------------|-------------------------|-----|-----|---------------------------|
|  |            | R                       | G   | B   |                           |
| Forward Current <sup>Note 1</sup>                    | $I_F$      | 50                      | 35  | 20  | mA                        |
| Peak Forward Current <sup>Note 2</sup>               | $I_{FP}$   | 200                     | 100 | 100 | mA                        |
| Reverse Voltage                                      | $V_R$      | 5                       | 5   | 5   | V                         |
| Power Dissipation                                    | $P_D$      | 130                     | 133 | 76  | mW                        |
| Operation Temperature                                | $T_{opr}$  | -40 ~ +85               |     |     | $^\circ\text{C}$          |
| Storage Temperature                                  | $T_{stg}$  | -40 ~ +100              |     |     | $^\circ\text{C}$          |
| Junction Temperature                                 | $T_J$      | 110                     | 110 | 110 | $^\circ\text{C}$          |
| Junction/ambient                                     | $R_{THJA}$ | 440                     | 480 | 420 | $^\circ\text{C}/\text{W}$ |
| Junction/solder point                                | $R_{THJS}$ | 180                     | 230 | 200 | $^\circ\text{C}/\text{W}$ |
| Electrostatic Discharge Classification(MIL-STD-883E) | ESD        | 1000 V                  |     |     |                           |

**Note:** 1.Single-color light.  
2.Pulse width  $\leq 0.1$  msec, duty  $\leq 1/10$ .

### TYPICAL ELECTRICAL & OPTICAL CHARACTERISTICS ( $T_A = 25^\circ\text{C}$ )

| Characteristics                         | Condition  | Symbol           | Values  |         |         | Unit          |
|---|--|------------------|---------|---------|---------|---------------|
|   |  |                  | R       | G       | B       |               |
| Dominant Wavelength                     | $I_F = 15$ mA(R)<br>$I_F = 10$ mA(G)<br>$I_F = 10$ mA(B) | $\lambda_{DOM}$  | 619~624 | 520~540 | 460~480 | nm            |
| Spectral bandwidth at 50% $I_{REL}$ max | $I_F = 15$ mA(R)<br>$I_F = 10$ mA(G)<br>$I_F = 10$ mA(B) | $\Delta \lambda$ | 24      | 38      | 28      | nm            |
| Forward Voltage                         | $I_F = 15$ mA(R)<br>$I_F = 10$ mA(G)<br>$I_F = 10$ mA(B) | $V_{F(avg)}$     | 2.1     | 3.0     | 3.0     | V             |
|   |  | $V_{F(max)}$     | 2.6     | 3.8     | 3.8     | V             |
| Luminous Intensity                      | $I_F = 15$ mA(R)<br>$I_F = 10$ mA(G)<br>$I_F = 10$ mA(B) | $I_{V(min)}$     | 355     | 710     | 140     | mcd           |
|   |  | $I_{V(avg)}$     | 500     | 900     | 245     | mcd           |
| Luminous Intensity (Reference)          | $I_F = 20$ mA(R/G/B)                                     | $I_{V(avg)}$     | 680     | 1500    | 460     | mcd           |
| Reverse Current (max)                   | $V_R = 5$ V  | $I_R$            | 10      | 10      | 10      | $\mu\text{A}$ |

**INTENSITY BIN LIMIT (RED  $I_F = 15$  mA, GREEN  $I_F = 10$  mA, BLUE  $I_F = 10$  mA)**

Red

| Bin Code | Min.(mcd) | Max.(mcd) |
|----------|-----------|-----------|
| H        | 355       | 450       |
| hj       | 403       | 505       |
| J        | 450       | 560       |
| km       | 505       | 635       |
| K        | 560       | 710       |
| np       | 635       | 805       |

Green

| Bin Code | Min.(mcd) | Max.(mcd) |
|----------|-----------|-----------|
| M        | 710       | 900       |
| qr       | 805       | 1010      |
| N        | 900       | 1120      |
| st       | 1010      | 1260      |
| P        | 1120      | 1400      |

Blue

| Bin Code | Min.(mcd) | Max.(mcd) |
|----------|-----------|-----------|
| D        | 140       | 180       |
| 9a       | 160       | 202       |
| E        | 180       | 224       |
| bc       | 202       | 252       |
| F        | 224       | 280       |
| de       | 252       | 318       |
| G        | 280       | 355       |

Tolerance of measurement of luminous intensity is  $\pm 10\%$ .

**COLOR BIN LIMIT (RED  $I_F = 15$  mA, GREEN  $I_F = 10$  mA, BLUE  $I_F = 10$  mA)**

Red

| Bin Code | Min.(nm) | Max.(nm) |
|----------|----------|----------|
| RB       | 619      | 624      |

Green

| Bin Code | Min.(nm) | Max.(nm) |
|----------|----------|----------|
| G7       | 520      | 525      |
| G23      | 522.5    | 527.5    |
| G8       | 525      | 530      |
| G45      | 527.5    | 532.5    |
| G9       | 530      | 535      |
| G67      | 532.5    | 537.5    |
| Ga       | 535      | 540      |

Blue

| Bin Code | Min.(nm) | Max.(nm) |
|----------|----------|----------|
| B3       | 460      | 465      |
| B23      | 462.5    | 467.5    |
| B4       | 465      | 470      |
| B45      | 467.5    | 472.5    |
| B5       | 470      | 475      |
| B67      | 472.5    | 477.5    |
| B6       | 475      | 480      |

Tolerance of measurement of dominant wavelength is  $\pm 1$  nm.

**ORDER CODE TABLE\***

| Kit Number                 | Color | Luminous Intensity (mcd)                   |      | Dominant Wavelength (nm)             |           |           |           | Pack-<br>age |
|----------------------------|-------|--|------|--------------------------------------|-----------|-----------|-----------|--------------|
|                            |       | Min.                                       | Max. | Color Bin                            | Min. (nm) | Color Bin | Max. (nm) |              |
| CLY6C-FKC-CHnpMPDGBB7a363  | Red   | 355  | 805  | RB                                   | 619       | RB        | 624       | Reel         |
|                            | Green | 710  | 1400 | G7                                   | 520       | Ga        | 540       | Reel         |
|                            | Blue  | 140  | 355  | B3                                   | 460       | B6        | 480       | Reel         |
| CLY6C-FKC-CH1M1D1BB7D3D3   | Red   | Any 1 Intensity bin from H(355) - np(805)  |      | RB                                   | 619       | RB        | 624       | Reel         |
|                            | Green | Any 1 Intensity bin from M(710) - P(1400)  |      | Any 1 hue bin from G7(520) - Ga(540) |           |           |           | Reel         |
|                            | Blue  | Any 1 Intensity bin from D(140) - G(355)   |      | Any 1 hue bin from B3(460) - B6(480) |           |           |           | Reel         |
| CLY6C-FKC-Chj1qr1E1BB7D3D3 | Red   | Any 1 Intensity bin from hj(403) - np(805) |      | RB                                   | 619       | RB        | 624       | Reel         |
|                            | Green | Any 1 Intensity bin from qr(805) - P(1400) |      | Any 1 hue bin from G7(520) - Ga(540) |           |           |           | Reel         |
|                            | Blue  | Any 1 Intensity bin from E(180) - G(355)   |      | Any 1 hue bin from B3(460) - B6(480) |           |           |           | Reel         |

Notes:

1. The above kit numbers represent the order codes which include multiple intensity-bin and color-bin codes. Only one intensity-bin code and one color-bin code will be shipped on each reel. Single intensity-bin code and single color-bin code will be orderable in certain quantities. For example, any 1 intensity bin from M - P means only 1 intensity bin (M or qr or N or st or P) will be shipped by Cree. For example, any 1 color bin from G7 - Ga means only 1 color bin (G7 or G23 or G8 or G45 or G9 or G67 or Ga) will be shipped by Cree.
2. Please refer to the "Cree LED Lamp Reliability Test Standards" document #1 for reliability test conditions.
3. Please refer to the "Cree LED Lamp Soldering & Handling" document #2 for information about how to use this LED product safely.

#1: Refer to [http://www.cree.com/led-components/media/documents/LED\\_Lamp\\_Reliability\\_Test\\_Standard.pdf](http://www.cree.com/led-components/media/documents/LED_Lamp_Reliability_Test_Standard.pdf)

#2: Refer to <http://www.cree.com/led-components/media/documents/sh-HB.pdf>

## GRAPHS

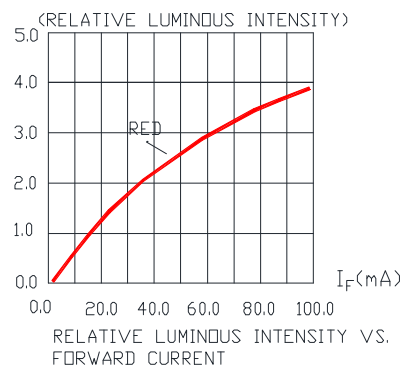
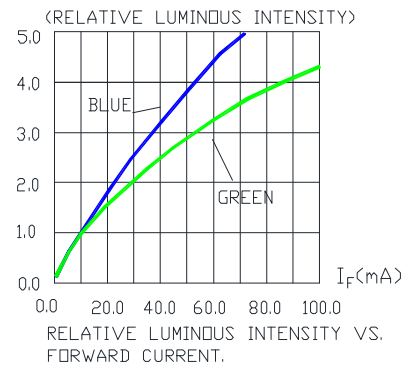
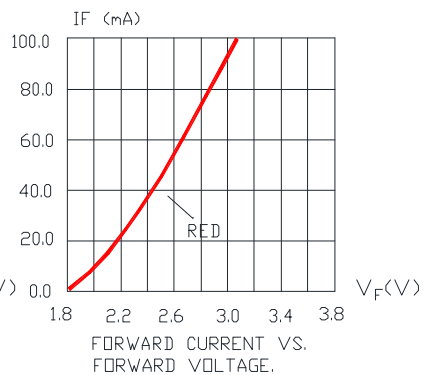
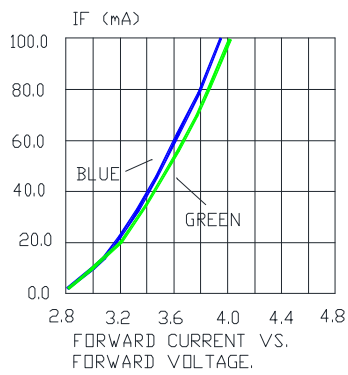
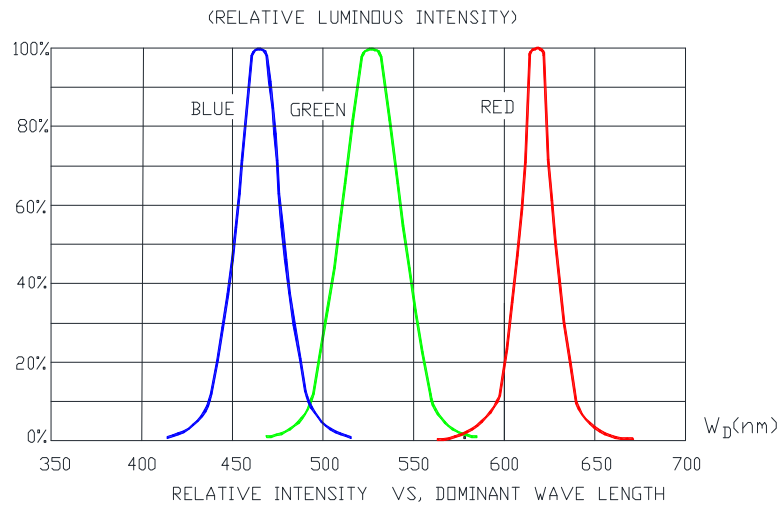

The above data are collected from statistical figures that do not necessarily correspond to the actual parameters of each single LED. Hence, these data will be changed without further notice.

## GRAPHS

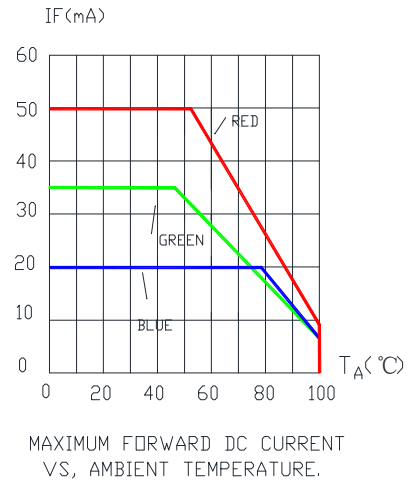
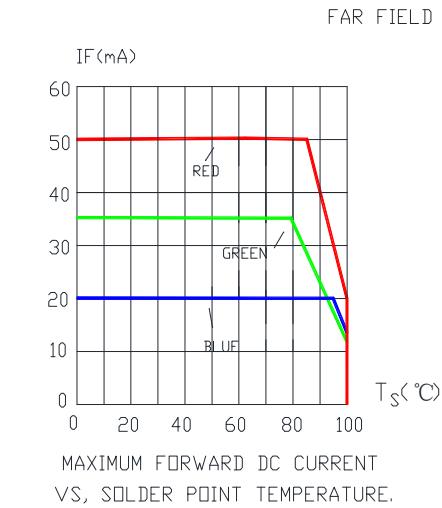
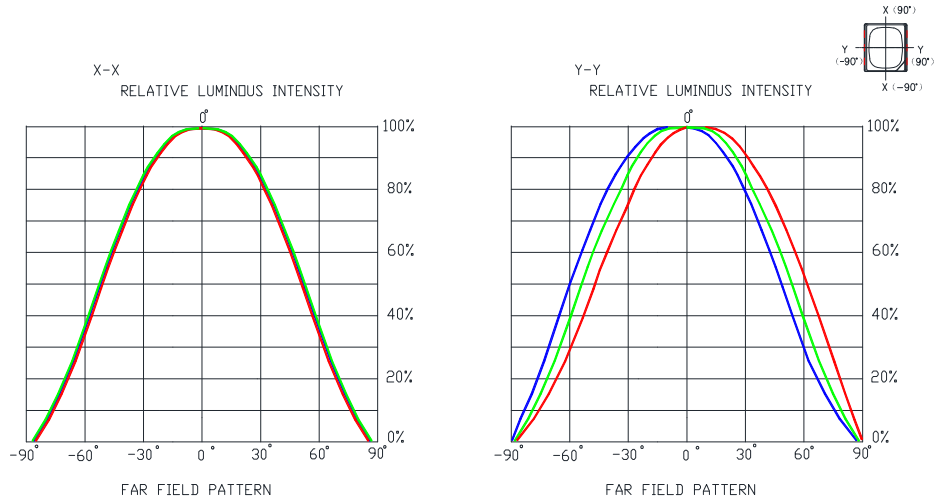

The above data are collected from statistical figures that do not necessarily correspond to the actual parameters of each single LED. Hence, these data will be changed without further notice.

## MECHANICAL DIMENSIONS

All dimensions are in mm.

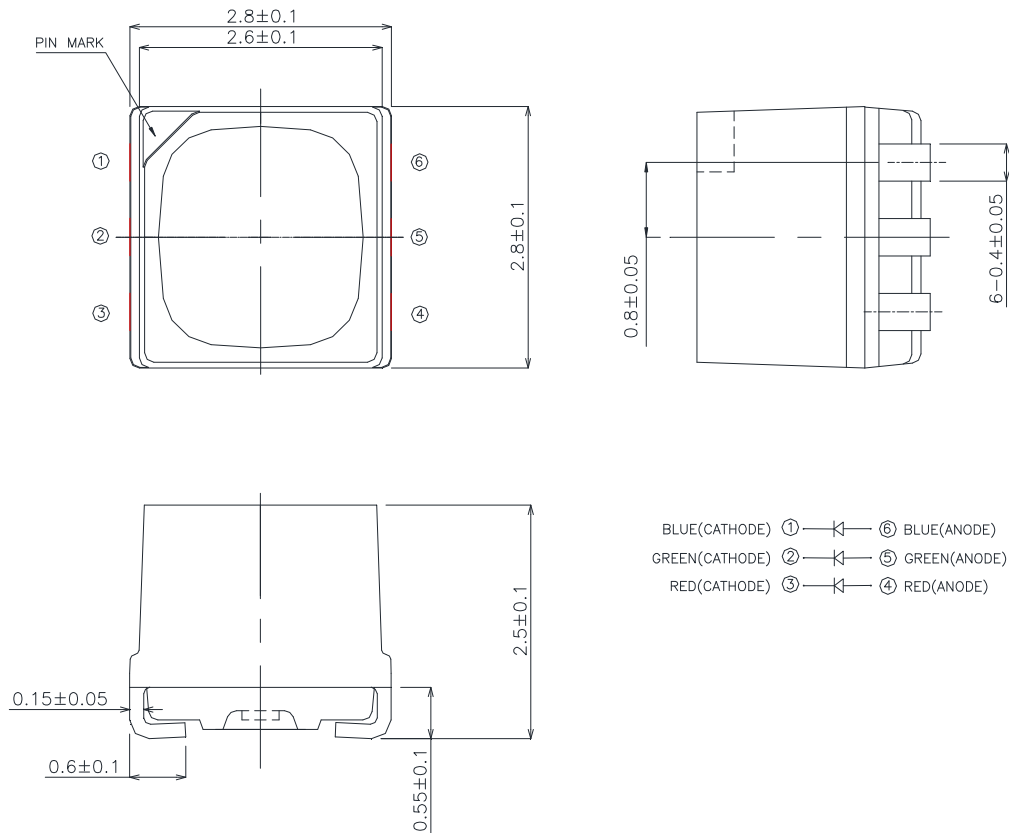

## NOTES

### RoHS Compliance

The levels of environmentally sensitive, persistent biologically toxic (PBT), persistent organic pollutants (POP), or otherwise restricted materials in this product are below the maximum concentration values (also referred to as the threshold limits) permitted for such substances, or are used in an exempted application, in accordance with EU Directive 2002/95/EC on the restriction of the use of certain hazardous substances in electrical and electronic equipment (RoHS), as amended through April 21, 2006.

### Vision Advisory Claim

Users should be cautioned not to stare at the light of this LED product. The bright light can damage the eye.

## KIT NUMBER SYSTEM

Cree LED lamps are tested and sorted into performance bins. A bin is specified by ranges of color, forward voltage, and brightness. Sorted LEDs are packaged for shipping in various convenient options. Please refer to the "Cree LED Lamp Packaging Standard" document for more information about shipping and packaging options.

Cree LEDs are sold by order codes in combinations of bins called kits. Order codes are configured in the following manner:

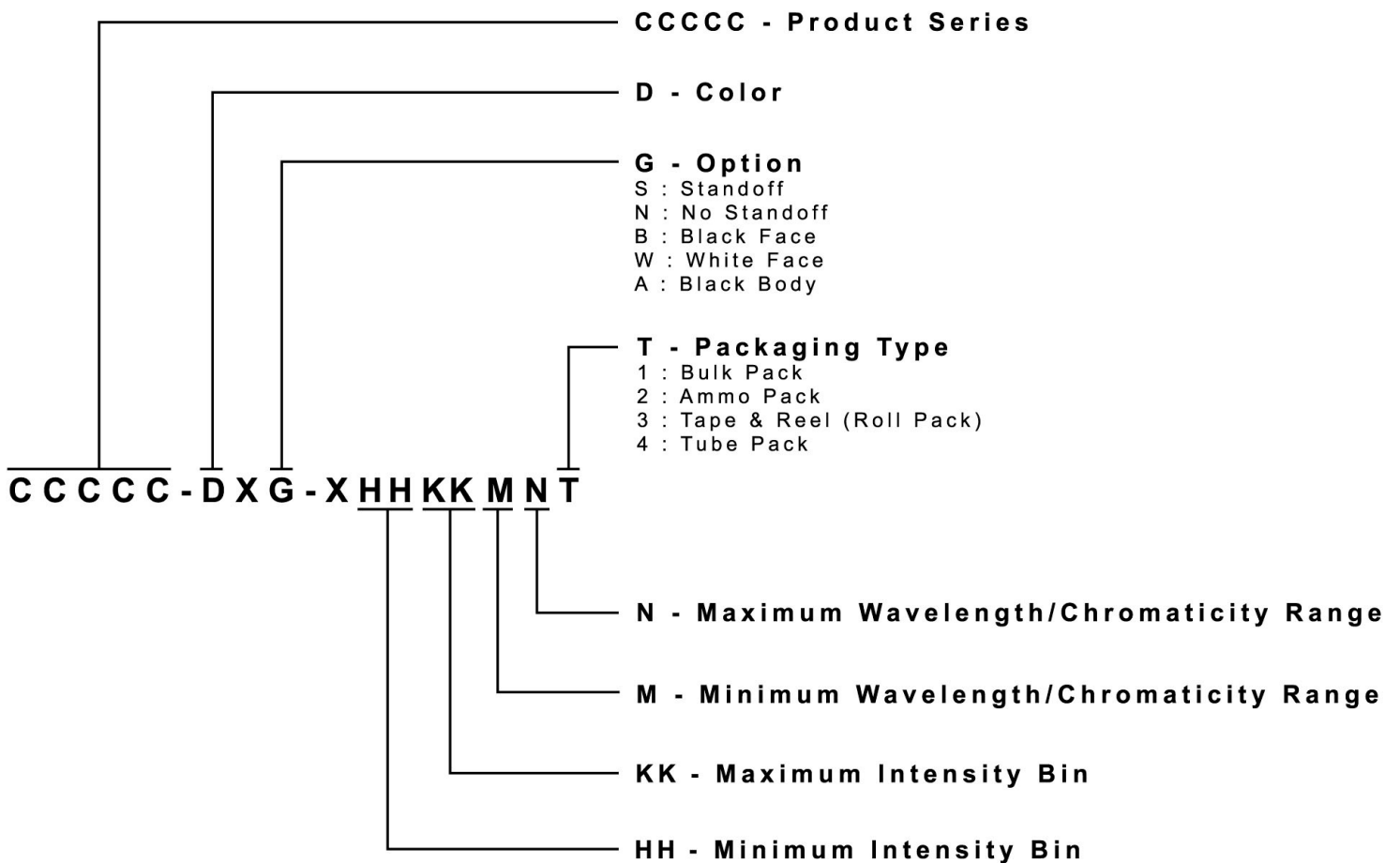



## REFLOW SOLDERING

- The CLY6C-FKC is rated as a MSL 5a product.
- The recommended floor life out of bag is 24hrs.
- The temperature profile is as below.

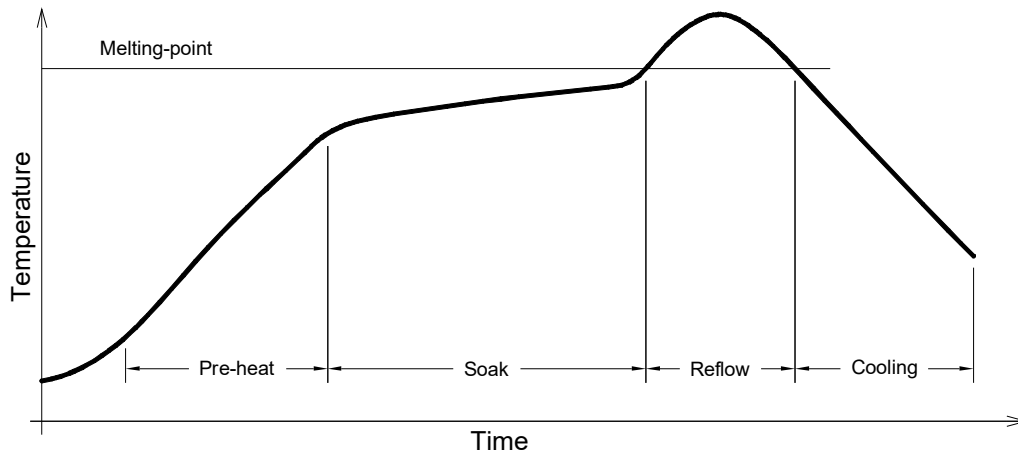

Use only with CLY6C-FKC

| Solder   |
|--|
| Average ramp-up rate = 4°C/s max                     |
| Preheat temperature = 150°C ~200°C                   |
| Preheat time = 120s max                              |
| Ramp-down rate = 6°C/s max                           |
| Peak temperature = 235°C max                         |
| Time within 5°C of actual Peak Temperature = 10s max |
| Duration above 217°C is 45s max                      |

Refer to "<http://www.cree.com/led-components/media/documents/sh-HB.pdf>" for soldering & handling details.

## NOTES

---

- The packaging sizes of these SMD products are very small and the resin is still soft after solidification. Users are required to handle with care. Never touch the resin surface of SMD products.
- To avoid damaging the product's surface and interior device, it is recommended to choose a special nozzle to pick up the SMD products during the process of SMT production. If handling is necessary, take special care when picking up these products. The following method is necessary:



## PACKAGING

- The boxes are not water resistant and they must be kept away from water and moisture.
- The LEDs are packed in cardboard boxes after packaging in normal or anti-electrostatic bags.
- Cardboard boxes will be used to protect the LEDs from mechanical shocks during transportation.
- The reel pack is applied in SMD LED.
- Max 6500 pcs per reel.

