

# Cree® PLCC6 3 in 1 SMD LED CLX6F-RKB

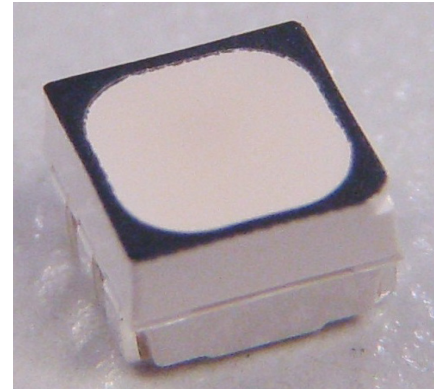

## PRODUCT DESCRIPTION

These SMD LEDs are packaged in an industry standard PLCC6 package. These high reliability and high brightness LEDs are designed to work in a wide range of environmental condition and are ideally suited for use in illumination applications.

Its wide viewing angle makes these LEDs ideally suited for channel letter, or general backlighting and illumination applications. The flat top emitting surface makes it easy for these LEDs to mate with light pipes.

## FEATURES

- Size (mm): 3.5 x 3.4 x 2.8
- Dominant Wavelength: Red (619 - 624nm)
- Luminous Intensity (mcd) Red (2240-3550)
- Water-Resistant (IPX8)\*
- Moisture Sensitivity Level: 5a
- Lead-Free
- RoHS Compliant
- Matte Surface

## APPLICATIONS

- Architecture Lighting
- Channel Letter
- Backlight

\*: This part is tested under the condition of assembling it on a PCB with isolating the electrical path by silicone. The leads area of the LED is not IPx8 rated and it's required to insulate for moisture by customer in outdoor application.

## ABSOLUTE MAXIMUM RATINGS ( $T_A = 25^\circ\text{C}$ )

Items	Symbol	Absolute Maximum Rating	Unit
Forward Current <sup>Note 1</sup>	$I_F$	3 x 50	mA
Peak Forward Current <sup>Note 2</sup>	$I_{FP}$	3 x 200	mA
Reverse Voltage	$V_R$	5	V
Power Dissipation	$P_D$	3 x 130	mW
Operation Temperature	$T_{opr}$	-40 ~ +85	$^\circ\text{C}$
Storage Temperature	$T_{stg}$	-40 ~ +100	$^\circ\text{C}$
Junction Temperature	$T_J$	110	$^\circ\text{C}$
Junction/ambient 1 chip on	$R_{THJA}$	450	$^\circ\text{C}/\text{W}$
Junction/solder point 1 chip on	$R_{THJS}$	230	$^\circ\text{C}/\text{W}$
Electrostatic Discharge Classification(MIL-STD-883E)	ESD	1000 V	

**Note:** 1.Single-color light.  
2.Pulse width  $\leq 0.1$  msec, duty  $\leq 1/10$ .

## TYPICAL ELECTRICAL & OPTICAL CHARACTERISTICS ( $T_A = 25^\circ\text{C}$ )

Characteristics	Condition	Symbol	Values	Unit
Dominant Wavelength	$I_F = 3 \times 20$ mA	$\lambda_{DOM}$	619~624	nm
Spectral bandwidth at 50% $I_{REL}$ max	$I_F = 3 \times 20$ mA	$\Delta \lambda$	24	nm
Forward Voltage	$I_F = 3 \times 20$ mA	$V_{F(avg)}$	2.1	V
		$V_{F(max)}$	2.6	V
Luminous Intensity	$I_F = 3 \times 20$ mA	$I_{V(min)}$	2240	mcd
		$I_{V(avg)}$	2800	mcd
Luminous Flux(Reference)	$I_F = 3 \times 20$ mA	$\Phi_{V(avg)}$	8.4	lm
Reverse Current (max)	$V_R = 5$ V	$I_R$	10	$\mu\text{A}$

**INTENSITY BIN LIMIT ( $I_F = 3 \times 20 \text{ mA}$ )**

Red

Bin Code	Min.(mcd)	Max.(mcd)
S	2240	2800
1b1c	2520	3175
T	2800	3550

Tolerance of measurement of luminous intensity is  $\pm 10\%$ .**COLOR BIN LIMIT ( $I_F = 3 \times 20 \text{ mA}$ )**

Red

Bin Code	Min.(nm)	Max.(nm)
RB	619	624

Tolerance of measurement of dominant wavelength is  $\pm 1 \text{ nm}$ .

**ORDER CODE TABLE\***

Kit Number	Color	Luminous Intensity (mcd)		Dominant Wavelength (nm)				Package
		Min.	Max.	Color Bin	Min. (nm)	Color Bin	Max. (nm)	
CLX6F-RKB-CSTBB3	Red	2240	3550	RB	619	RB	624	Reel
CLX6F-RKB-CS1BB3	Red	Any 1 Intensity bin from S(2240) - T(3550)		RB	619	RB	624	Reel

Notes:

1. The above kit numbers represent the order codes which include multiple intensity-bin and color-bin codes. Only one intensity-bin code and one color-bin code will be shipped on each reel. Single intensity-bin code and single color-bin code will be orderable in certain quantities. For example, any 1 intensity bin from S - T means only 1 intensity bin (S or 1b1c or T) will be shipped by Cree. For example, BB means only 1 color bin RB will be shipped by Cree.
2. Please refer to the "Cree LED Lamp Reliability Test Standards" document for reliability test conditions.
3. Please refer to the "Cree LED Lamp Soldering & Handling" document for information about how to use this LED product safely.

## GRAPHS

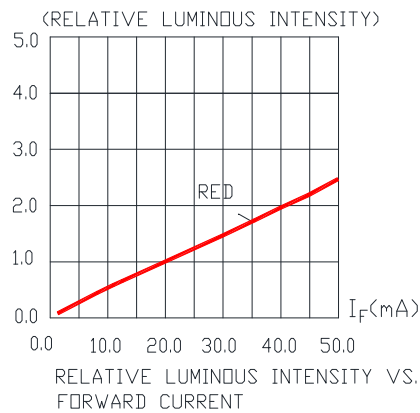
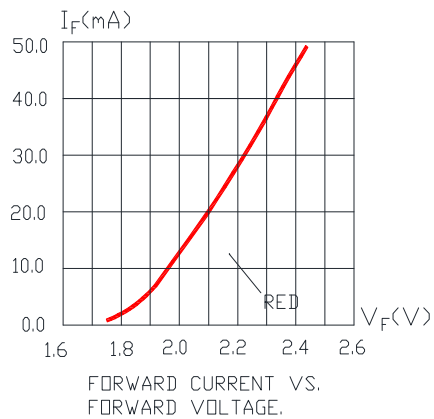
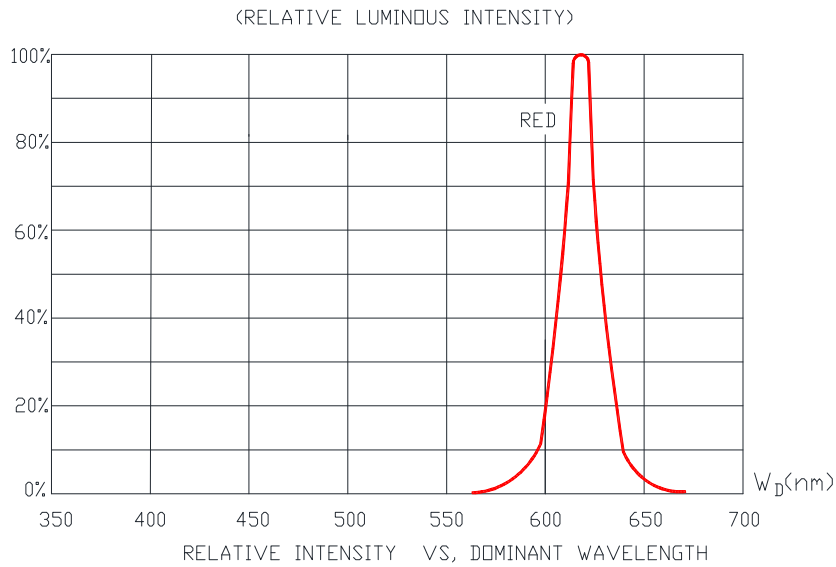

The above data are collected from statistical figures that do not necessarily correspond to the actual parameters of each single LED. Hence, these data will be changed without further notice.

## GRAPHS

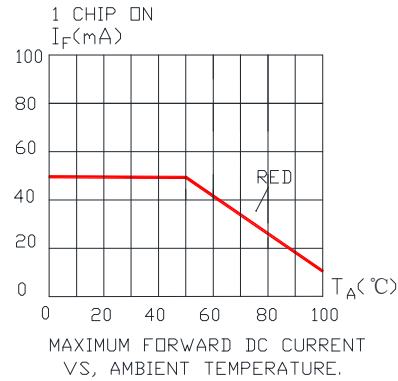
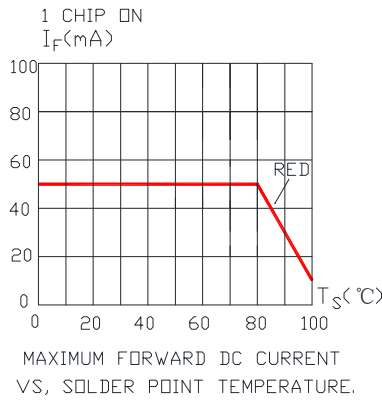
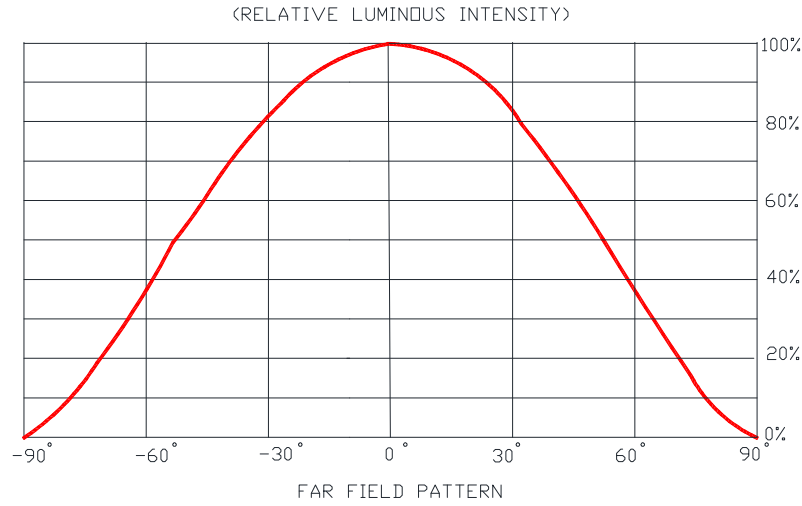

The above data are collected from statistical figures that do not necessarily correspond to the actual parameters of each single LED. Hence, these data will be changed without further notice.

## MECHANICAL DIMENSIONS

All dimensions are in mm.

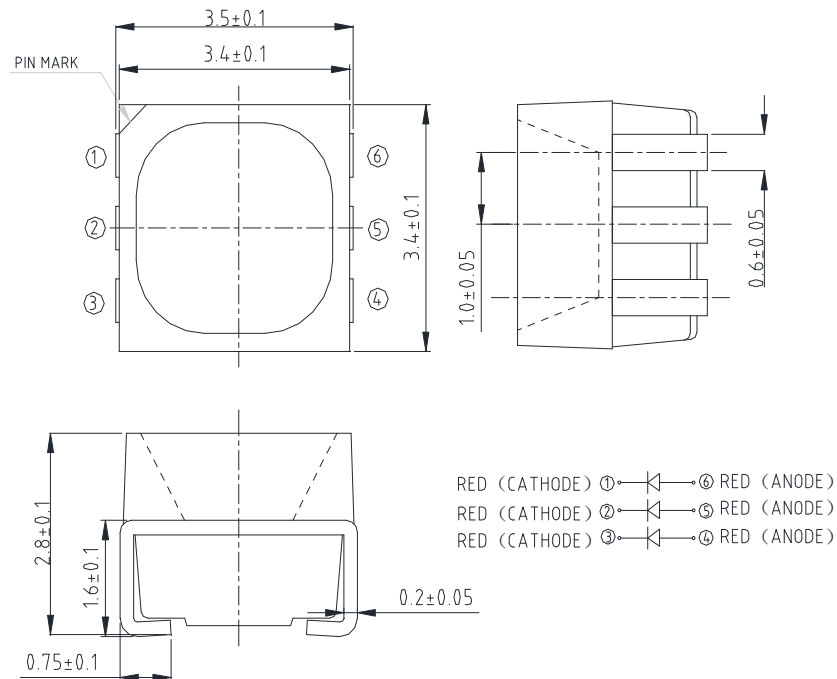

## NOTES

### RoHS Compliance

The levels of environmentally sensitive, persistent biologically toxic (PBT), persistent organic pollutants (POP), or otherwise restricted materials in this product are below the maximum concentration values (also referred to as the threshold limits) permitted for such substances, or are used in an exempted application, in accordance with EU Directive 2002/95/EC on the restriction of the use of certain hazardous substances in electrical and electronic equipment (RoHS), as amended through April 21, 2006.

### Vision Advisory Claim

Users should be cautioned not to stare at the light of this LED product. The bright light can damage the eye.

## KIT NUMBER SYSTEM

Cree LED lamps are tested and sorted into performance bins. A bin is specified by ranges of color, forward voltage, and brightness. Sorted LEDs are packaged for shipping in various convenient options. Please refer to the "Cree LED Lamp Packaging Standard" document for more information about shipping and packaging options.

Cree LEDs are sold by order codes in combinations of bins called kits. Order codes are configured in the following manner:

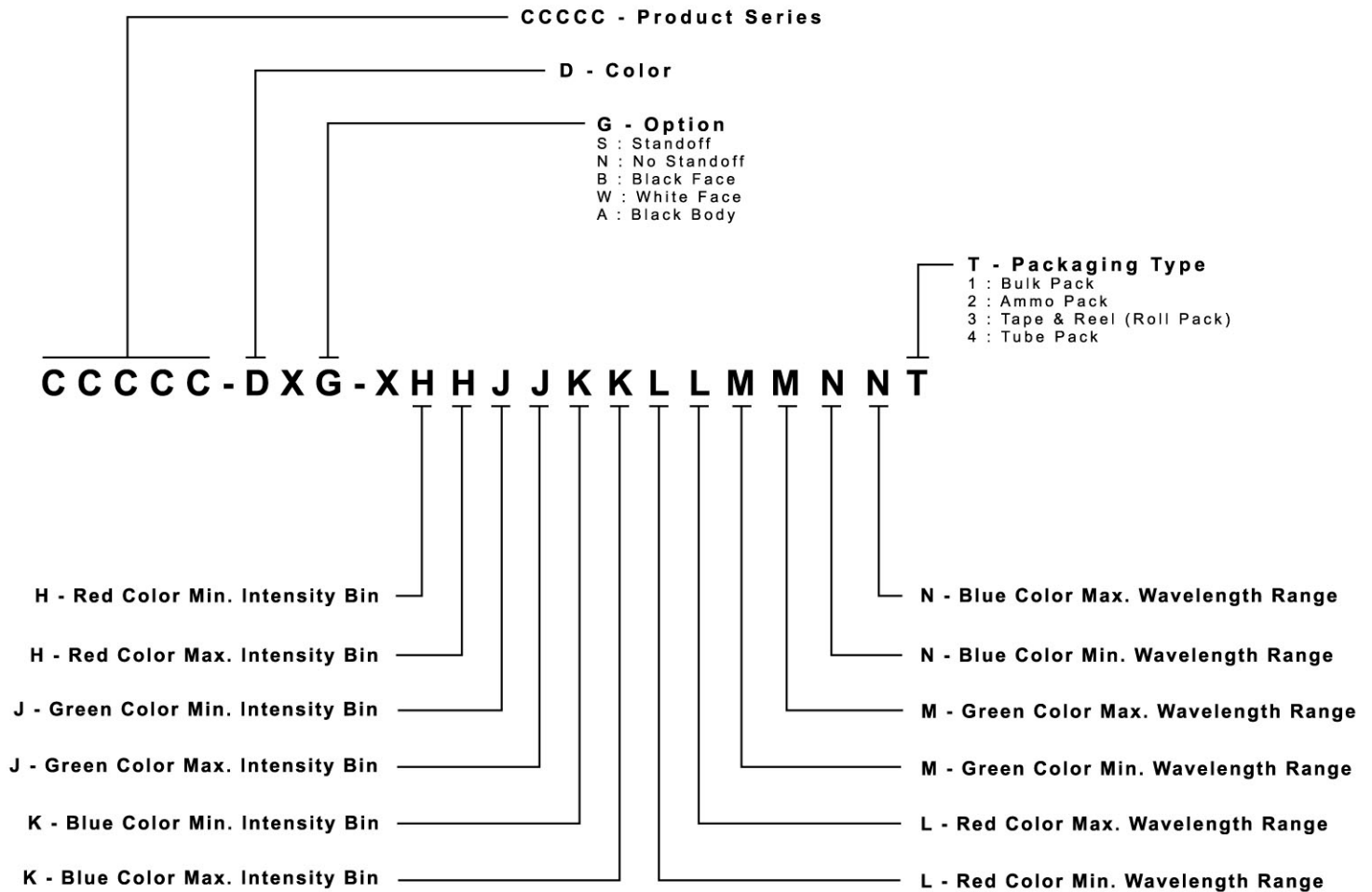



## REFLOW SOLDERING

- The CLX6F-RKB is rated as a MSL 5a product.
- The recommended floor life out of bag is 24hrs.
- The temperature profile is as below.

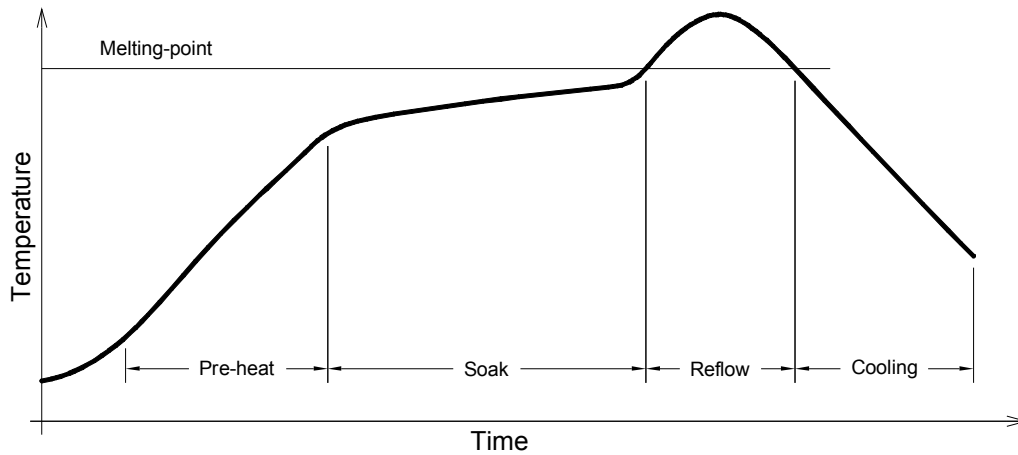

Use only with CLX6F-RKB

Solder
Average ramp-up rate = 4°C/s max
Preheat temperature = 150°C ~200°C
Preheat time = 120s max
Ramp-down rate = 6°C/s max
Peak temperature = 250°C max
Time within 5°C of actual Peak Temperature = 10s max
Duration above 217°C is 60s max

## PACKAGING

- The boxes are not water resistant and they must be kept away from water and moisture.
- The LEDs are packed in cardboard boxes after packaging in normal or anti-electrostatic bags.
- Cardboard boxes will be used to protect the LEDs from mechanical shocks during transportation.
- The reel pack is applied in SMD LED.
- Max 2800 pcs per reel.

