

Cree® PLCC2 1 in 1 SMD LED CLM3A-BKW/GKW

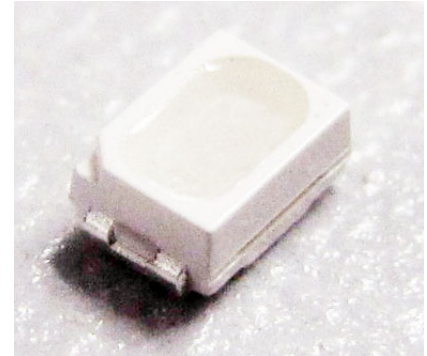

PRODUCT DESCRIPTION

SMD LEDs is packaged in the industry standard package. These LEDs have high reliability performance and are designed to work under a wide range of environmental conditions.

This high reliability feature makes them ideally suited to be used under illumination application conditions.

Its wide viewing angle makes these LEDs ideally suited for channel letter, or general backlighting and illumination applications. The flat top emitting surface makes it easy for these LEDs to mate with light pipes.

FEATURES

- Size (mm): 2.7 x 2.0
- Color and Typical Dominant Wavelength:
Blue (470nm)
Green (525nm)
- Luminous Intensity (mcd)
CLM3A-BKW: (355 - 900)
CLM3A-GKW: (1120 - 2240)
- Lead-Free
- RoHS Compliant

APPLICATIONS

- Channel Letter
- Architectural Lighting

ABSOLUTE MAXIMUM RATINGS ($T_A = 25^\circ\text{C}$)

Items	Symbol	Absolute Maximum Rating	Unit
		BKW/GKW	
Forward Current	I_F	25	mA
Peak Forward Current ^{Note}	I_{FP}	100	mA
Reverse Voltage	V_R	5	V
Power Dissipation	P_D	100	mW
Operation Temperature	T_{opr}	-40 ~ +100	$^\circ\text{C}$
Storage Temperature	T_{stg}	-40 ~ +100	$^\circ\text{C}$
Junction Temperature	T_J	110	$^\circ\text{C}$

Note: Pulse width ≤ 0.1 msec, duty $\leq 1/10$.

TYPICAL ELECTRICAL & OPTICAL CHARACTERISTICS ($T_A = 25^\circ\text{C}$)

Characteristics	Color	Symbol	Condition	Unit	Minimum	Typical	Maximum
Forward Voltage	BKW/GKW	V_F	$I_F = 20$ mA	V		3.1	4.0
Reverse Current	BKW/GKW	I_R	$V_R = 5$ V	μA			10
Dominant Wavelength	BKW	λ_D	$I_F = 20$ mA	nm	465	470	480
	GKW	λ_D	$I_F = 20$ mA	nm	520	527	535
Luminous Intensity	BKW	I_v	$I_F = 20$ mA	mcd	355	500	
	GKW	I_v	$I_F = 20$ mA	mcd	1120	1400	
Junction/Solder Point	BKW	R_{THJS}	$I_F = 20$ mA	$^\circ\text{C}/\text{W}$		350	
	GKW	R_{THJS}	$I_F = 20$ mA	$^\circ\text{C}/\text{W}$		380	

INTENSITY BIN LIMIT ($I_F = 20 \text{ mA}$)

Blue (CLM3A-BKW)

Bin Code	Min.(mcd)	Max.(mcd)
Tb	355	450
Ua	450	560
Ub	560	710
Va	710	900

Green (CLM3A-GKW)

Bin Code	Min.(mcd)	Max.(mcd)
Wa	1120	1400
Wb	1400	1800
Xa	1800	2240

Tolerance of measurement of luminous intensity is $\pm 10\%$.

COLOR BIN LIMIT ($I_F = 20 \text{ mA}$)

Blue (CLM3A-BKW)

Bin Code	Min.(nm)	Max.(nm)
B4	465	470
B5	470	475
B6	475	480

Green (CLM3A-GKW)

Bin Code	Min.(nm)	Max.(nm)
G7	520	525
G8	525	530
G9	530	535

Tolerance of measurement of dominant wavelength is $\pm 1 \text{ nm}$.

ORDER CODE TABLE*

Color	Kit Number	Luminous Intensity (mcd)		Dominant Wavelength			
		Min.	Max.	Color Bin	Min.(nm)	Color Bin	Max.(nm)
Blue	CLM3A-BKW-CTbVa463	355	900	B4	465	B6	480
Blue	CLM3A-BKW-CUaVa453	450	900	B4	465	B5	475

Color	Kit Number	Luminous Intensity (mcd)		Dominant Wavelength			
		Min.	Max.	Color Bin	Min.(nm)	Color Bin	Max.(nm)
Green	CLM3A-GKW-CWaXa793	1120	2240	G7	520	G9	535
Green	CLM3A-GKW-CWaXa783	1120	2240	G7	520	G8	530

Notes:

1. The above kit numbers represent order codes that include multiple intensity-bin and color-bin codes. Only one intensity-bin code and one color-bin code will be shipped on each bulk. Single intensity-bin code and single color-bin codes will not be orderable.
2. Please refer to the "Cree LED Lamp Reliability Test Standards" document for reliability test conditions.
3. Please refer to the "Cree LED Lamp Soldering & Handling" document for information about how to use this LED product safely.

GRAPHS

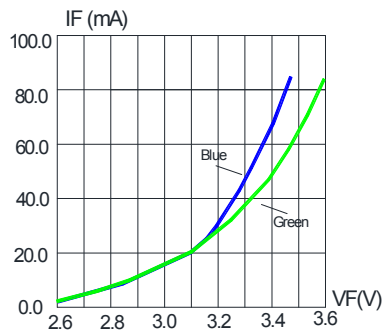

FIG. 1 FORWARD CURRENT VS. FORWARD VOLTAGE.

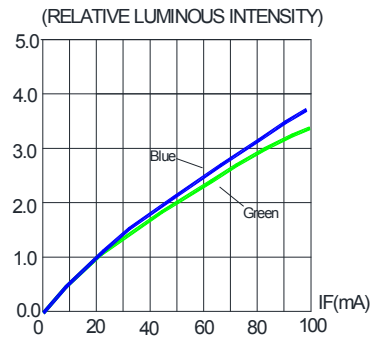

FIG. 2 RELATIVE LUMINOUS INTENSITY VS. FORWARD CURRENT

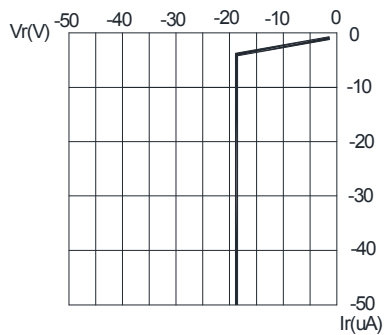

FIG. 3 BLUE&GREEN REVERSE CURRENT VS. REVERSE VOLTAGE.

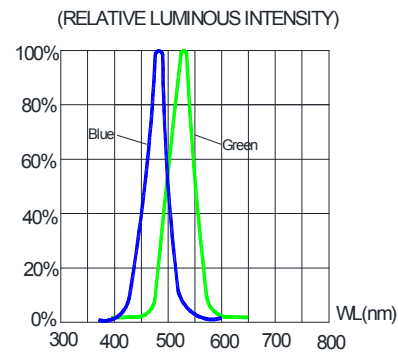

FIG. 4 RELATIVE LUMINOUS INTENSITY VS. WAVELENGTH.

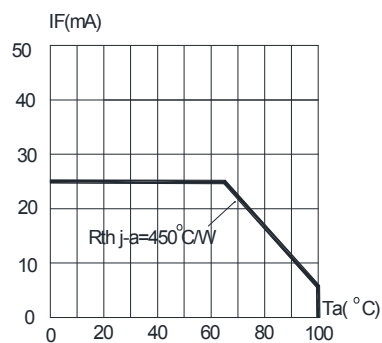

FIG. 5 BLUE&GREEN MAXIMUM FORWARD DC CURRENT VS AMBIENT TEMPERATURE ($T_{jmax}=110^{\circ}C$)

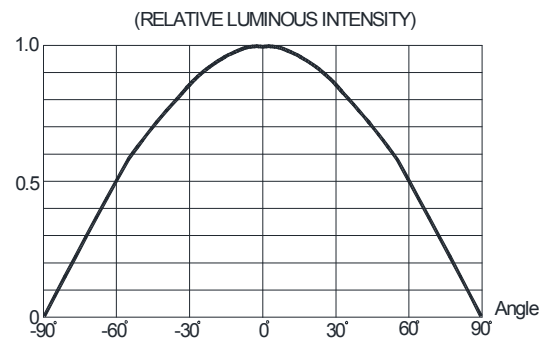
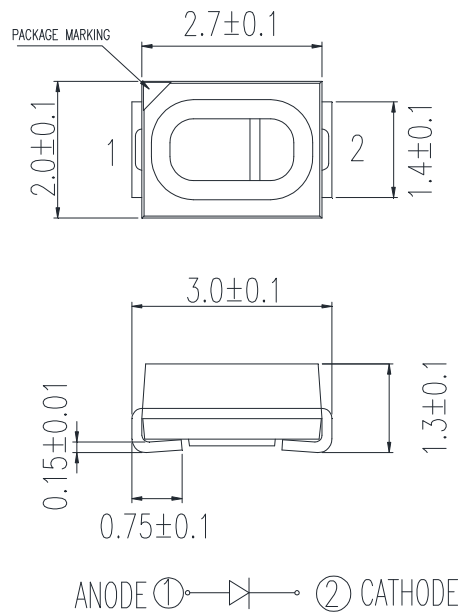

FIG. 6 FAR FIELD PATTERN

The above data are collected from statistical figures that do not necessarily correspond to the actual parameters of each single LED. Hence, these data will be changed without further notice.

MECHANICAL DIMENSIONS

All dimensions are in mm.



NOTES

RoHS Compliance

The levels of environmentally sensitive, persistent biologically toxic (PBT), persistent organic pollutants (POP), or otherwise restricted materials in this product are below the maximum concentration values (also referred to as the threshold limits) permitted for such substances, or are used in an exempted application, in accordance with EU Directive 2002/95/EC on the restriction of the use of certain hazardous substances in electrical and electronic equipment (RoHS), as amended through April 21, 2006.

Vision Advisory Claim

Users should be cautioned not to stare at the light of this LED product. The bright light can damage the eye.

KIT NUMBER SYSTEM

Cree LED lamps are tested and sorted into performance bins. A bin is specified by ranges of color, forward voltage, and brightness. Sorted LEDs are packaged for shipping in various convenient options. Please refer to the "Cree LED Lamp Packaging Standard" document for more information about shipping and packaging options.

Cree LEDs are sold by order codes in combinations of bins called kits. Order codes are configured in the following manner:



PACKAGING

- The boxes are not water resistant and they must be kept away from water and moisture.
- The LEDs are packed in cardboard boxes after packaging in normal or anti-electrostatic bags.
- Cardboard boxes will be used to protect the LEDs from mechanical shocks during transportation.
- The reel pack is applied in SMD LED.
- Max 2500 pcs per reel.

