

## Peak Sensitivity Wavelength: 925nm

The MTD1114M3B is a photo diode in a ceramic package. It is well suited for high reliability and high sensitivity applications.

### FEATURES

- > Very High Light Current
- > Compact / Ceramic Package
- > High Reliability in Demanding Environments

### APPLICATIONS

- > Optical Switches
- > Optical Sensors
- > Optical Detectors

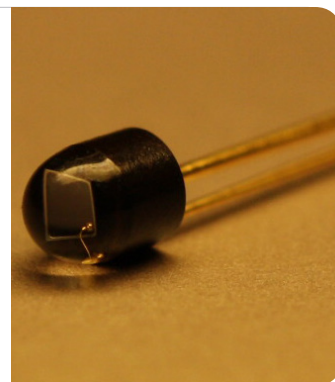

## Absolute Maximum Ratings (Ta=25°C)



ITEMS	SYMBOL	RATINGS	UNIT
Reverse Voltage	VR	20	V
Power Dissipation	PD	70	mW
Operating Temperature Range	Topr	-20 ~ +85	°C
Storage Temperature Range	Tstg	-30 ~ +100	°C
Junction Temperature	Tj	100	°C
Lead Soldering Temperature*1	Tls	260	°C

\*1: Time 5 Sec max, Position: Up to 3mm from the body.

## Electrical & Optical Characteristics (Ta = 25°C)

ITEMS	SYMBOL	CONDITIONS	MIN	TYP	MAX	UNIT
Open Circuit Voltage	Voc	Ee=5mW/cm <sup>2</sup> *1	--	0.35	--	V
Light Current	IL	*1, *2	--	38	--	μA
Dark Current	ID	VR=10V	--	0.5	5	nA
Curve Factor	CF	Ee=5mW/cm <sup>2</sup> *1	0.55	--	--	--
Spectral Sensitivity	λ	--	--	400~1100	--	nm
Peak Sensitivity Wavelength	λp	--	--	925	--	nm
Angular Response	Θ	--	--	±65	--	deg.
Switching Time (Rise Time)	Tr	RL=50Ω, Vr=0V	--	--	2	μS
Switching Time (Fall Time)	Tf	RL=50Ω, Vr=0V	--	--	2	μS
Junction Capacitance	Cj	at 1MHz, V=0V	--	100	130	pF

\*1: Color Temperature=2870°K Standard Tungsten Lamp, \*2: VR=10V, Ee=5mW/cm<sup>2</sup>.

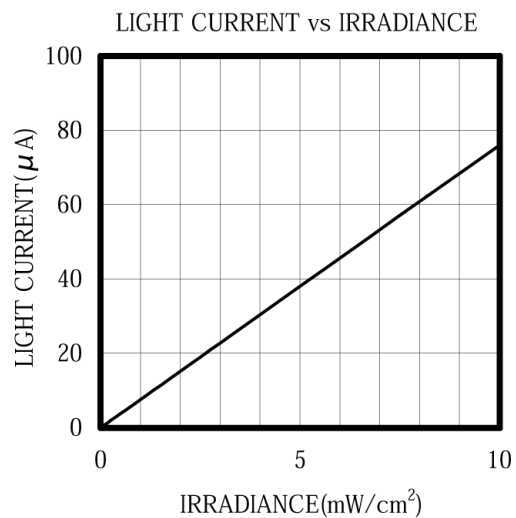
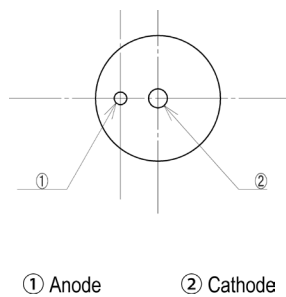
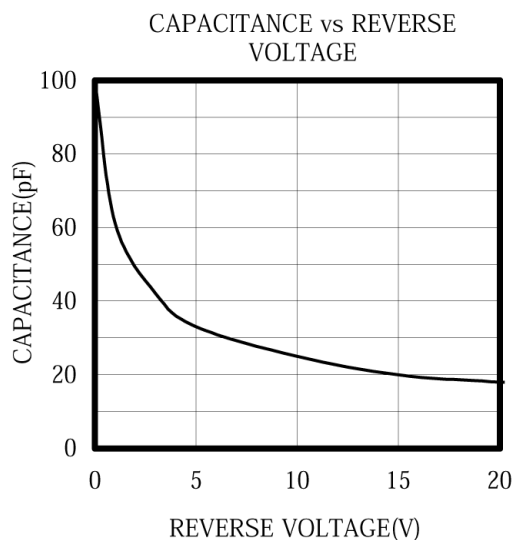
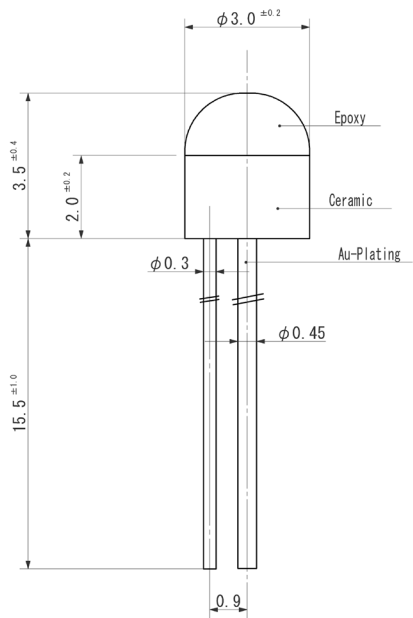

Unit: mm, Tolerance:  $\pm 0.2$

ANGULAR DISPLACEMENT

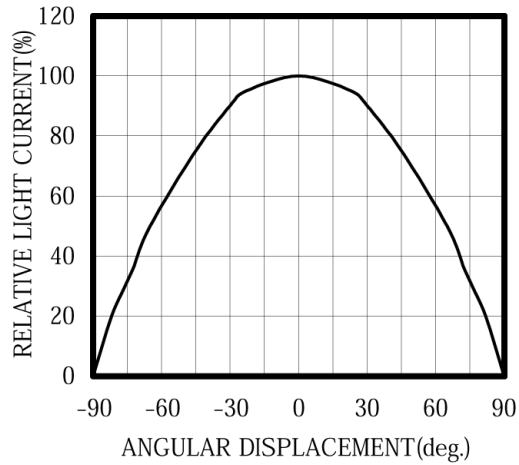

THERMAL DERATING CURVE

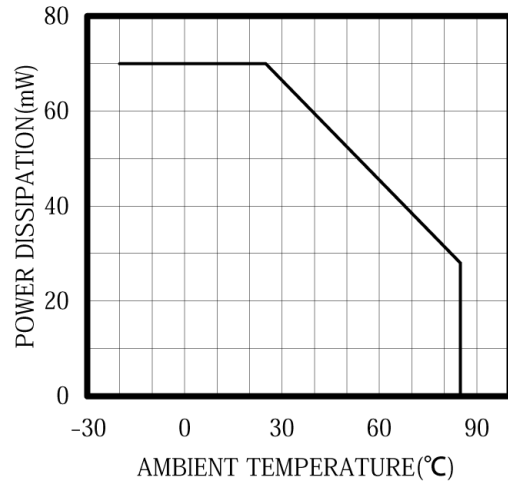

RESPONSIVITY

