

## Sensitivity Wavelength Range: 250-1100nm

The MT03-036 is a square (2.74 x 2.74) 7.5mm<sup>2</sup> active area Silicon Photodiode in a hermetic TO-5 metal can package with a UV transmitting glass window. It is optimized for applications requiring high sensitivity in the 300 to 500nm region (UVA, Blue & Green).

### Features

- > Ultra Low Noise
- > High Shunt Resistance
- > Wide Dynamic Range
- > 365nm & Blue/Green Enhanced

### Applications

- > Flame Detection
- > Currency Authentication
- > Spectroscopy Equipment
- > Fluorescence

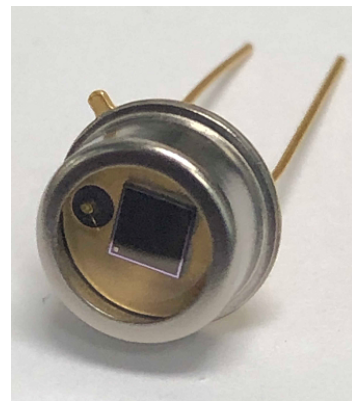

## Absolute Maximum Ratings



Items	Symbol	Rating	Unit
Reverse Voltage	V <sub>R</sub>	50	V
Operating Temperature Range	T <sub>opr</sub>	-40 ~ +100	°C
Storage Temperature Range	T <sub>stg</sub>	-55 ~ +125	°C
Lead Soldering Temperature*1	T <sub>ls</sub>	260	°C

\*1: Time 5 Sec max, Position: Up to 3mm from the body.

## Electrical & Optical Characteristics (T<sub>a</sub> = 23°C)

Items	Symbol	Conditions	MIN	TYP	MAX	Unit
Dark Current	I <sub>d</sub>	V <sub>R</sub> =5V	--	0.1	1.0	nA
Breakdown Voltage	V <sub>(BR)</sub>	I <sub>R</sub> =10μA	50	--	--	V
Spectral Sensitivity	λ	--	--	250-1100	--	nm
Peak Sensitivity Wavelength	λ <sub>p</sub>	--	--	950	--	nm
Responsivity	R	V <sub>R</sub> =0V, λ=365nm	--	0.22	--	A/W
Responsivity	R	V <sub>R</sub> =0V, λ=633nm	--	0.40	--	A/W
Response Time @635nm	T <sub>r</sub>	R <sub>L</sub> =50Ω, V <sub>R</sub> =5V	--	30	--	ns
Junction Capacitance	C <sub>j</sub>	@ 1MHz, V <sub>R</sub> =0V	--	110	--	pF
Junction Capacitance	C <sub>j</sub>	@ 1MHz, V <sub>R</sub> =5V	--	35	40	pF
Shunt Resistance	R <sub>sh</sub>	V <sub>R</sub> =10mV	200	400	--	MΩ

TO-5 Package Dimensions (2 Pin)

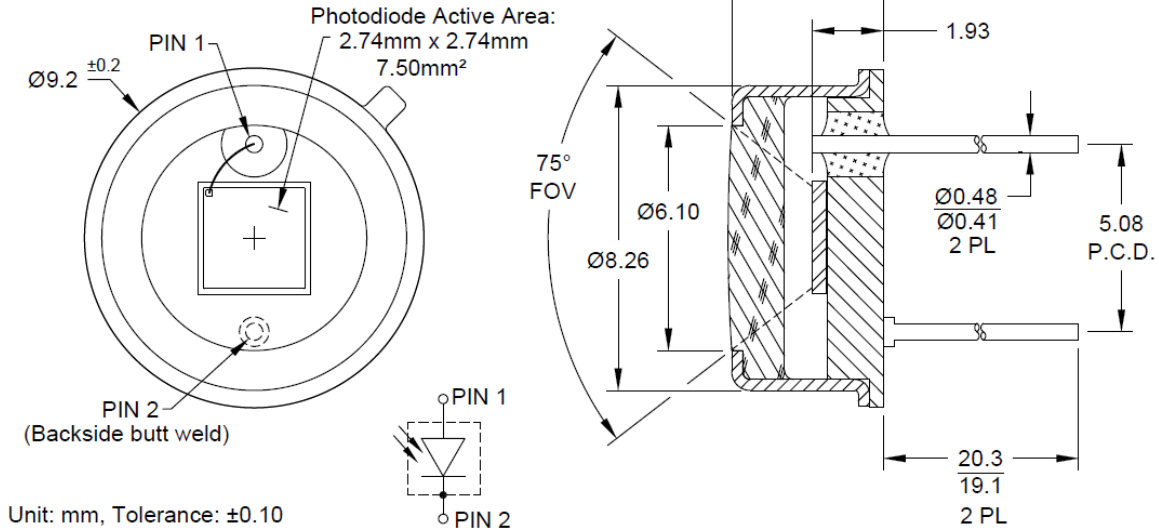

Capacitance vs Reverse Bias

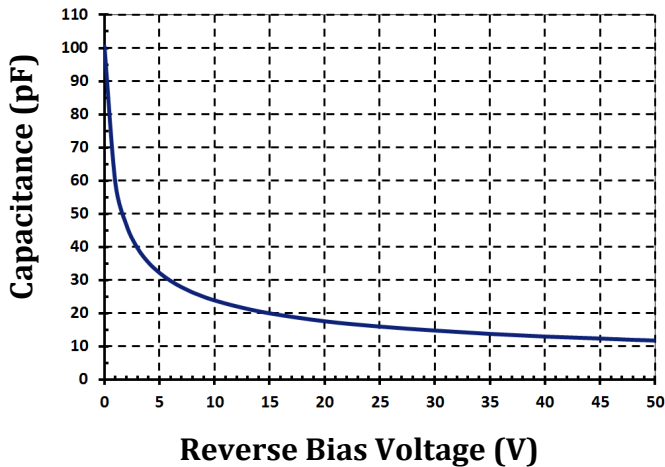

Dark Current vs Reverse Bias (23°C)

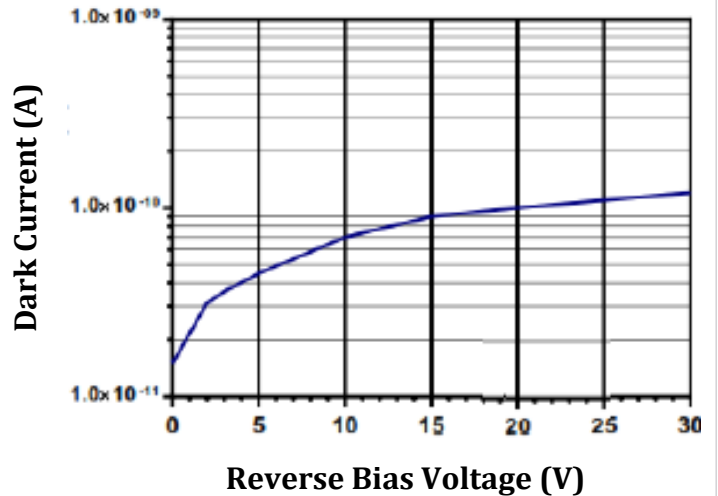

Dark Current vs Temperature ( $V_r=10V$ )

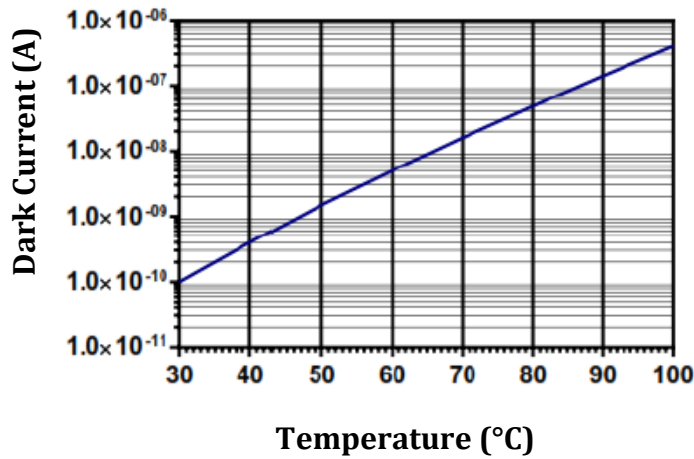

Series 4 Quantum Efficiency (23°C)

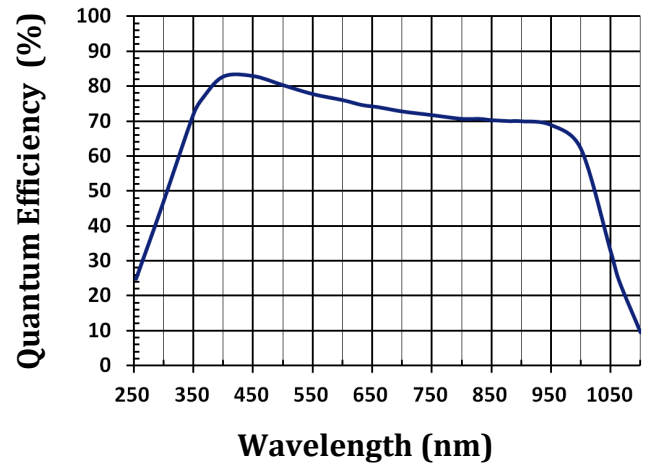

Photodiode Responsivity by Series

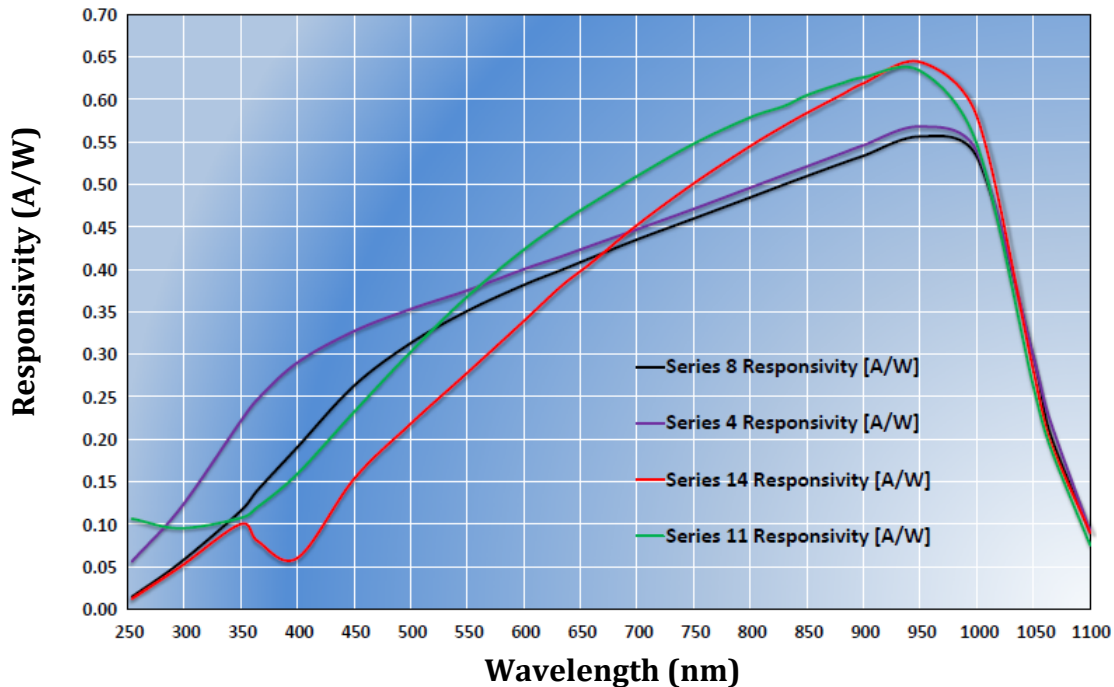

The information contained herein is subject to change without notice.

2019-03